

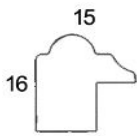

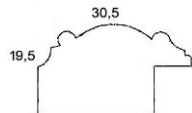
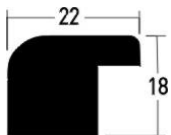
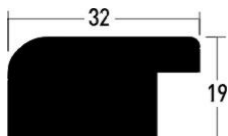
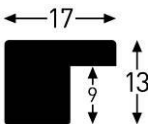
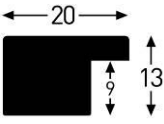
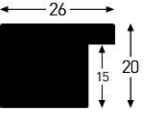

TRÆPROFILER

| | Mængden indeholder ca. |
|---|--|
| <p>Antique</p> <p>1615-18 Valnød 1615-00 Valnød Guld</p>  <p>1930-18 Valnød</p>  | <p>18 meter 18 meter</p> <p>12 meter</p> |
| <p>Aquarelle</p> <p>22404 Sort 22412 Kirsebærrød 22434 Kongebå 22780 Sølv 22762 Kirsebær lys 22763 Kirsebær mørk 22764 Oliven 22770 Guld</p>  <p>40704 Sort 40770 Guld 40780 Sølv 40764 Oliven</p>  | <p>10 meter</p> |
| <p>Blackwoods Ecocare. (flere på side 2)</p> <p>95404 Sort mat</p>  <p>95804 Sort mat</p>  <p>96104 Sort mat</p>  <p>96404 Sort mat</p>  | <p>12 meter</p> |

TRÆPROFILER

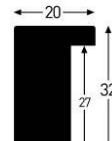
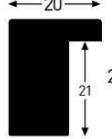
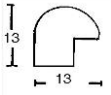
| | Mængden indeholder ca. |
|--|---|
| <p>Blackwoods Ecocare.</p> <p>95504 Sort mat </p> <p>95204 Sort mat </p> <p>95304 Sort mat </p> | <p>12 meter</p> |
| <p>Bomberino</p> <p>1313-07 Kobber </p> <p>1511-01 Guld 1511-03 Sølv </p> <p>1913-01 Guld 1913-03 Sølv 1913-21 Sort mat </p> <p>2617-01 Guld 2617-03 Sølv 2617-21 Sort mat </p> <p>3019-01 Guld 3019-03 Sølv 3019-21 Sort mat </p> | <p>12 meter</p> <p>12 meter</p> <p>12 meter</p> |

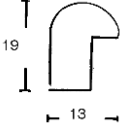
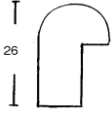
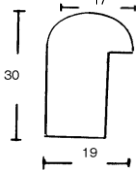

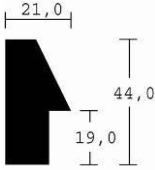
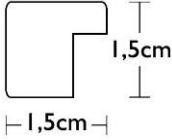
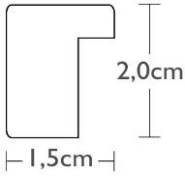
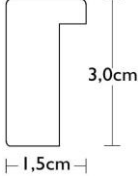
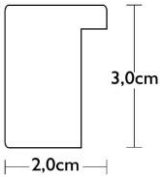
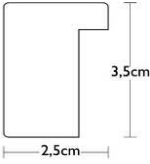
TRÆPROFILER

| | Mængden indeholder ca. |
|--|---|
| <p>Canyon</p> <p>84268 Grå</p>  | 6 meter |
| <p>CAP</p> <p>41339 Hvid mat 41340 Sort mat 41301 Guld 41341 Sølv 41342 Super hvid</p>  <p>41439 Hvid mat 41440 Sort mat 41401 Guld 41441 Sølv 41442 Super hvid</p>  <p>41539 Hvid mat 41540 Sort mat 41501 Guld 41541 Sølv 41542 Super hvid</p>  <p>42039 Hvid mat 42040 Sort mat 42001 Guld 42041 Sølv 42042 Super hvid</p>  <p>52539 Hvid mat 52540 Sort mat 52501 Guld 52541 Sølv 52542 Super hvid</p>  | 12 meter 12 meter 12 meter 12 meter 12 meter 6 meter |

TRÆPROFILER

| | | Mængden indeholder ca. |
|--|----------|---|
| <p>Cap Hammerslag</p> <p>42118 Guld/sort kant 42141 Sølv/sort kant</p> | | 6 meter |
| <p>Cap Line</p> <p>42134 Hvid med brun kant 42135 Sort med rød kant</p> | | 12 meter |
| <p>Cap Natur</p> <p>2315-99 Fyr rå ubehandlet 2315-500 Fyr rå finer 2315-21 Fyr sort finer 2315-250 Fyr sort ubehandlet 2315-518 Mørk ask 2315-517 Røget eg</p> <p>3015-99 Fyr rå ubehandlet 3015-500 Fyr rå finer 3015-21 Fyr sort finer 3015-250 Fyr sort ubehandlet 3015-518 Mørk ask 3015-517 Røget eg 3015-530 Petroleum eg</p> <p>3220-99 Fyr rå ubehandlet 3220-500 Fyr rå finer 3220-21 Fyr sort finer 3220-250 Fyr sort ubehandlet 3220-518 Mørk ask 3220-517 Røget eg 3220-530 Petroleum eg</p> | | <p>12 meter</p> <p>12 meter</p> <p>12 meter</p> |

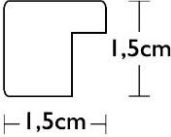
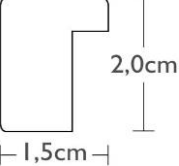
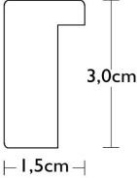
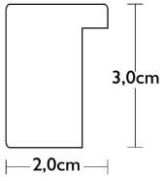
TRÆPROFILER

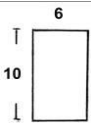
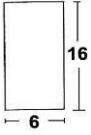
| | Mængden indeholder ca. |
|---|---|
| <p>Cap Struktur</p> <p>41337 Hvid mat 41338 Sort mat</p>  <p>1,5cm 1,5cm</p> <p>41437 Hvid mat 41438 Sort mat</p>  <p>2,0cm 1,5cm</p> <p>41537 Hvid mat 41538 Sort mat</p>  <p>3,0cm 1,5cm</p> <p>42037 Hvid mat 42038 Sort mat</p>  <p>3,0cm 2,0cm</p> | <p>12 meter</p> <p>12 meter</p> <p>12 meter</p> <p>12 meter</p> |
| <p>Cap Afstandsliste</p> <p>91430 Hvid 5 mm 91448 Sort 5 mm</p>  <p>5 5</p> <p>91530 Hvid 10 mm 91542 Superhvid 10mm 91548 Sort 10 mm 91517 Guld 10 mm 91543 Sølv 10 mm</p>  <p>6 10</p> <p>91630 Hvid 16 mm 91742 Superhvid 16mm 91648 Sort 16 mm 91617 Guld 16 mm 91643 Sølv 16 mm</p>  <p>16 6</p> | <p>30 meter</p> |

TRÆPROFILER

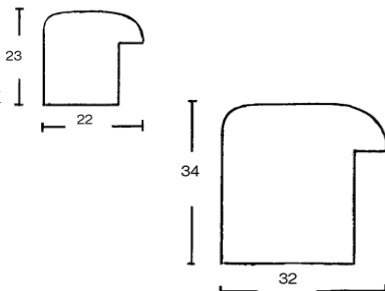
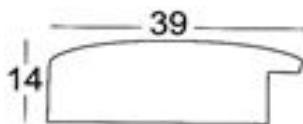
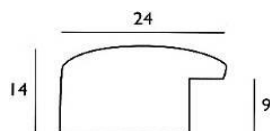
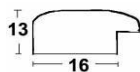
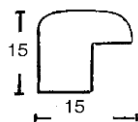

| | Mængden indeholder ca. |
|-------------------------|---------------------------|
| Cassetta | |
| 175-01 Guld | 12 meter |
| 175-03 Sølv | |
| 175-11 Mørkegrøn blank | |
| 175-21 Sort mat | 175-21=18 m |
| 175-16 Sort blank | |
| 175-27 Hvid blank | |
| 175-28 Rød | |
| 175-29 Gul | |
| 175-32 Modegrøn blank | |
| 175-52 Orange blank | |
| 175-56 Hvid mat | |
| 175-59 Ceriserød blank | |
| 175-85 Blå | |
| | |
| 1316-01 Guld | 12 meter |
| | |
| 3602-01 Guld | 12 meter |
| 3602-03 Sølv | |
| 3602-11 mørkegrøn blank | |
| 3602-16 Sort blank | |
| 3602-21 Sort mat | |
| 3602-27 Hvid blank | |
| 3602-28 Rød | |
| 3602-29 Gul | |
| 3602-32 modegrøn blank | |
| 3602-52 orange blank | |
| 3602-56 Hvid mat | |
| 3602-59 Ceriserød blank | |
| 3602-85 Blå | |
| | |
| 1439-16 Sort blank | 12 meter |
| 1439-27 Hvid blank | |
| | |
| 5772-01 Guld | 12 meter |
| 5772-03 Sølv | |
| 5772-21 Sort mat | |
| 5772-16 Sort blank | |
| 5772-27 Hvid mat | |
| | |
| 7102-01 Guld | 6 meter |
| 7102-03 Sølv | |
| 7102-21 Sort | |



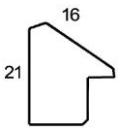
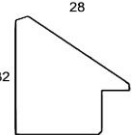
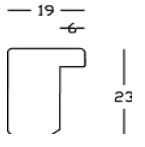
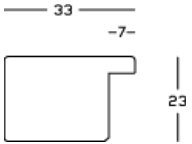

TRÆPROFILER

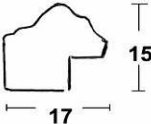
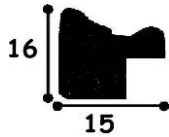
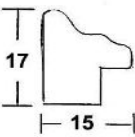
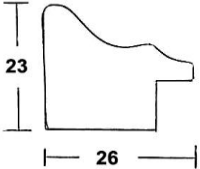
| | Mængden indeholder ca. |
|---|--|
| <p>Cassetta Lys Eg</p> <p>1817-514 Lys eg 18x17mm</p> <p>2518-514 Lys eg 25x18mm</p> <p>3325-514 Lys eg 33x25mm</p> | <p>12 meter</p> <p>12 meter</p> <p>6 meter</p> |
| <p>Chanell</p> <p>1621-224 Koks/sølv 1621-04 Aluminium</p>  <p>3228-224 Koks/sølv 3228-04 Aluminium</p>  | <p>6 meter</p> <p>6 meter</p> |
| <p>Cintra</p> <p>76202 Sølv 19 mm</p>  <p>76106 Guld 76189 Sort</p>  | <p>6 meter</p> |

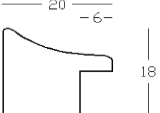
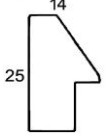
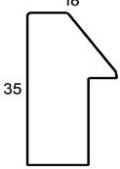
TRÆPROFILER

| | Mængden indeholder ca. |
|--|---|
| <p>Classic</p> <p>1522-01 Guld 1522-03 Sølv 1522-21 Sort mat</p>  <p>1615-01 Guld</p>  <p>1715-01 Guld 1715-03 Sølv</p>  <p>2326-01 Guld 2326-03 Sølv</p>  <p>3520-01 Guld 3520-03 Sølv 3520-21 Sort mat</p>  | <p>10 meter</p> <p>10 meter</p> <p>8 meter</p> <p>8 meter</p> <p>10 meter</p> |
| <p>Classico</p> <p>35601 Guld 35602 Sølv</p>  | <p>6 meter</p> |
| <p>Coco</p> <p>2514-21 Sort struktur 2514-27 Hvid struktur</p>  <p>3518-21 Sort struktur 3518-27 Hvid struktur</p>  | <p>6 meter</p> <p>6 meter</p> |

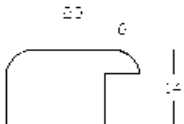
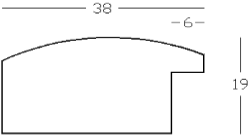
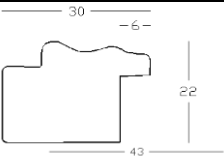

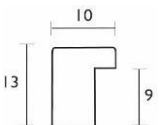
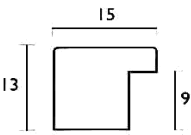
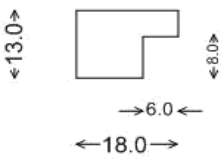
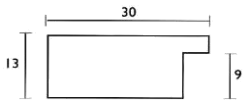
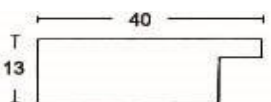
TRÆPROFILER

| | Mængden indeholder ca. |
|--|---|
| <p>Coloniale</p> <p>16245 Grå 16246 Gul</p>  <p>16387 Creme</p>  | 12 meter |
| <p>Corum</p> <p>90304 Sølv</p>  <p>90434 Sølv</p>  | 6 meter |
| <p>Flat</p> <p>Mini flat 1310-01 Guld Mini flat 1310-03 Sølv Mini flat 1310-21 Sort mat Mini flat 1310-56 Hvid mat</p>  <p>1315-01 Guld 1315-03 Sølv 1315-21 Sort 1315-56 hvid</p>  <p>1320-01 Guld 1320-03 Sølv 1320-21 Sort mat 1320-56 Hvid</p>  <p>1330-01 Guld 1330-03 Sølv 1330-21 Sort</p>  <p>1340-21 Sort 1340-56 Hvid</p>  | 12 meter 12 meter 12 meter 5 meter 6 meter 6 meter |

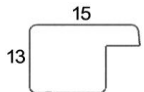
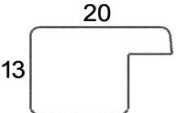
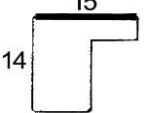
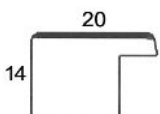
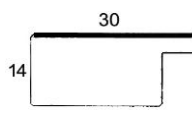
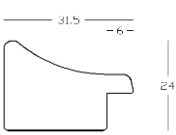
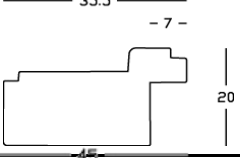
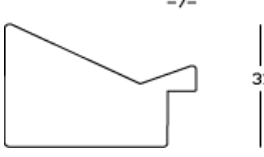
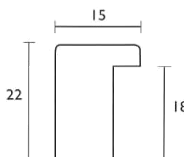



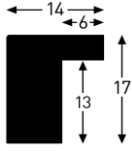
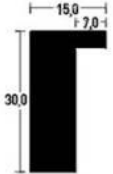
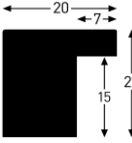

TRÆPROFILER

| | | Mængden indeholder ca. |
|--|---|---------------------------|
| Flat struktur 1315-250 Sort 1315-22 Brun valnød |  | 24 meter |
| 1320-250 Sort 1320-22 Brun valnød |  | 18 meter |
| Fugleøje 1415-211 Brun lak 15mm |  | 9,6 meter |
| 1420-211 Brun lak 20mm |  | 9,6 meter |
| 1430-211 Brun lak 30mm |  | 9,6 meter |
| Gobi 19303 Kirsebær |  | 12 meter |
| Havana 84320 Hvid |  | 6 meter |
| Linea 76317 Guld 76373 Sølv sten |  | 6 meter |
| Loft mini 2215-01 Guld 15 mm 2215-03 Sølv 2215-21 Sort 2215-56 Hvid |  | 10 meter |

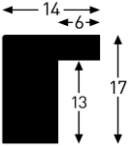
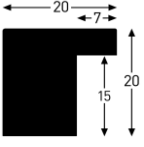
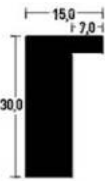
TRÆPROFILER

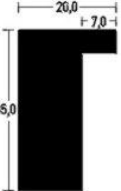
| | Mængden indeholder ca. |
|--|---|
| Loft Naturfarver | 6 meter |
| 40578 Natur hvid 14 mm 40579 Linde bark 40580 Grå 40581 Kakao 40582 Kaffe 40583 Antrazit |  |
| 40584 Natur hvid 15 mm 40585 Linde bark 40586 Grå 40587 Kakao 40588 Kaffe 40589 Anthrazit |  |
| 40590 Natur hvid 20 mm 40591 Linde bark 40592 Grå 40593 Kakao 40594 Kaffe 40595 Anthrazit |  |
| 40596 Natur hvid 20 mm 40597 Linde bark 40598 Grå 40599 Kakao 40600 Kaffe 40601 Anthrazit |  |
| 40602 Natur hvid 25 mm 40603 Linde bark 40604 Grå 40605 Kakao 40606 Kaffe 40607 Anthrazit |  |

TRÆPROFILER

| | Mængden indeholder ca. |
|---|---|
| Loft 40560 Ahorn 14 mm 40561 Eg 40563 Sort 40564 Hvid 40565 Bambus 40566 Wenge (brun) 40567 Teak 40570 Ahorn 20 mm 40571 Eg 40573 Sort 40574 Hvid 40575 Bambus 40576 Wenge (brun) 40577 Teak |   6 meter |
| Loft +(Indsatsliste) 40500 (40530) Ahorn 15 mm 40501 (40531) Eg 40502 (40532) Kirsebær (*) 40506 (40536) Wenge 40507 (40537) Teak 40503 (40533) Sort 40504 (40534) Hvid 3015-514 Hvid eg 3015-18 Valnød 40510 (40540) Ahorn 21 mm 40511 (40541) Eg 40512 (40542) Kirsebær (*) 40516 (40546) Wenge 40517 (40547) Teak 40513 (40543) Sort 40514 (40544) Hvid 3220-514 Hvid eg 32x20mm 3220-18 Valnød 3420-01 Guld 20 mm 3420-03 Sølv 40520 (40550) Ahorn 25 mm 40521 (40551) Eg 40522 (40552) Kirsebær (*) 40526 (40556) Wenge 40527 (40557) Teak 40523 (40553) Sort 40524 (40554) Hvid (*) = skaffevare |       6 (18) meter |

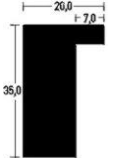
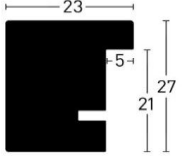
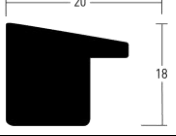
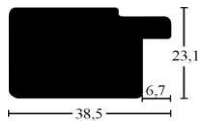

TRÆPROFILER

| | Mængden indeholder ca. |
|--|---------------------------|
| <p>Loft Colour lak</p> <p>31200 Hvid 20 mm 31201 Gul 31202 Orange 31203 Rød 31206 Blå 31209 Sort</p>  <p>Dimensions: 20,0 mm top width, 36,0 mm height, 7,0 mm top flange width.</p> | 6 meter |
| <p>Loft XL</p> <p>30153 Eg 30154 Wengé</p>  <p>Dimensions: 23 mm top width, 27 mm total height, 21 mm bottom height, 5 mm top flange width.</p> | 6 meter |
| <p>Metalia</p> <p>26701 Guld 20 mm 26702 Sølv</p>  <p>Dimensions: 20 mm top width, 18 mm height.</p> | 6 meter |
| <p>Metropolitan</p> <p>45414 Valnød sølv</p>  <p>Dimensions: 38,5 mm bottom width, 23,1 mm total height, 6,7 mm top flange width.</p> | 6 meter |

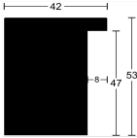
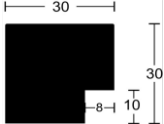
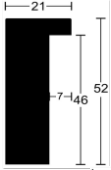
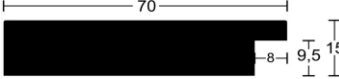
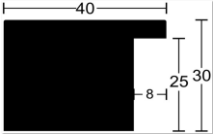
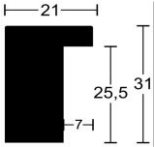
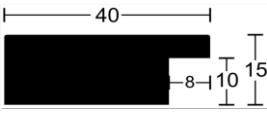
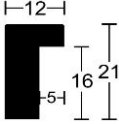
TRÆPROFILER

| | Mængden indeholder ca. |
|--|---------------------------|
| Oak Wood | |
| 54720 Eg  | 6 meter |
| 54721 Eg  | 6 meter |
| 54722 Eg  | 6 meter |
| 54723 Eg  | 6 meter |
| 54724 Eg  | 6 meter |
| 54725 Eg  | 12 meter |
| 54726 Eg  | 6 meter |
| 54727 Eg  | 12 meter |

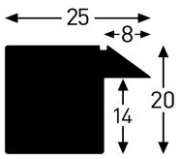
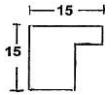
TRÆPROFILER

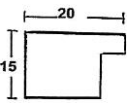
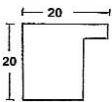
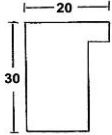
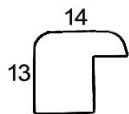
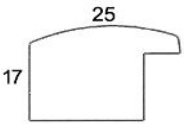
| | Mængden indeholder ca. |
|---|---------------------------|
| <p>Piano</p> <p>13806 Sølv</p>  | 6 meter |
| <p>Rovere Eg</p> <p>46167 Eg 15x15 mm</p>  <p>38500 Eg 19x13 mm</p>  <p>46267 Eg 15x20 mm</p>  <p>47202 Eg 20x20 mm</p>  <p>47267 Eg 30x20 mm</p>  | 6 meter |
| <p>Sahara</p> <p>17141 Sort/guld 14mm 17143 Guld/guld 17142 Hvid/elfenben</p>  <p>17251 Sort/guld 25mm 17253 Guld/guld 17252 Hvid/elfenben</p>  | 12 meter 12 meter |

TRÆPROFILER

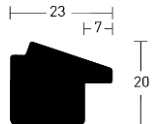
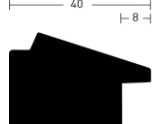
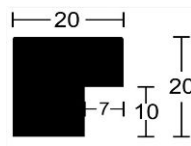
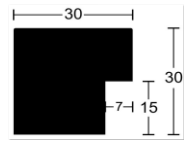
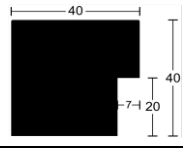
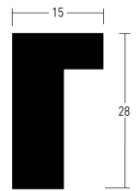
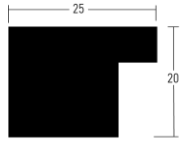
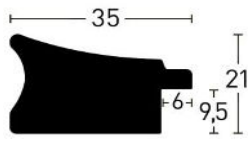
| | Mængden indeholder ca. |
|--|---------------------------------------|
| <p>Salon</p> <p>36001 Guld 23 mm</p>  <p>36104 Sort</p>  | 6 meter |
| <p>Scandi</p> <p>54740 Hvid 54741 Sort</p>  <p>54742 Hvid 54743 Sort</p>  <p>54744 Hvid 54745 Sort</p>  | 6 meter 6 meter 3 meter |
| <p>Sequoia</p> <p>16605 Eg</p>  <p>16705 Eg</p>  | 6 meter |
| <p>Sun</p> <p>54610 Sort 54612 Tin 54614 Sølv 54615 Bronze</p>  | 6 meter |

TRÆPROFILER

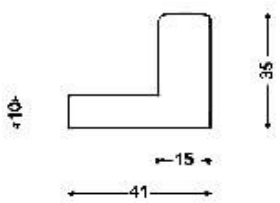
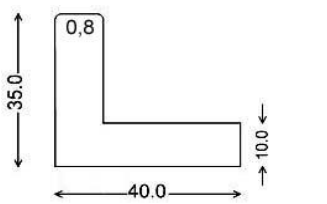
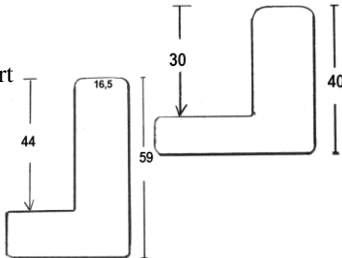
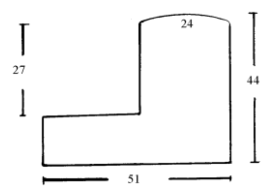
| | Mængden indeholder ca. |
|---|---|
| <p>Svæveliste Ved hele kasser (100 meter), ring for pris</p> <p>SV 01 Guld/rød SV 02 Sølv/sort - rød i sølv SV 03 Sølv/sort - sort i sølv</p> <p>SV B 01 Guld top/sort side SV B 03 Sølv top/sort side</p> <p>SV W 00 Hvid/hvid SV W 01 Guld/hvid SV W 03 Sølv/hvid</p> <p>SV NA Natur lys. SV BL Sort mat SV W Hvidt og slidt</p> <p>SV 113 Krydsbørstet antrasit SV 11 Krydsbørstet champagne</p> <p>SV E 01 Sort m. guld på top og side</p> <p>SV S 01 Smal Guld/sort SV S 03 Smal Sølv/sort SV S 21 Smal Sort mat SV S W 00 Hvid mat SV 85320 Havana</p> <p>SV M 01 Medium Guld/sort</p> <p>SV H 01 Høj Guld/sort SV H 03 Høj Sølv/sort SV H BL Høj sort mat SV HW 00 Høj hvid mat</p> <p>SV L 01 Bred guld/sort SV L 03 Bred sølv/sort SV L BL Bred sort mat SV LW 00 Bred hvid mat</p> | <p>18 meter</p>  <p>18 meter</p>  <p>12 meter</p>  <p>18 meter</p>  |



TRÆPROFILER

| | Mængden indeholder ca. |
|---|---------------------------|
| <p>Svæveliste Eg</p> <p>56409 Eg (Lille)</p> <p>56410 Eg (Stor)</p> | 12 meter |
| <p>Svæveliste Studio</p> <p>68401 Hvid Struktur</p> <p>68402 Brun Struktur</p> <p>68403 Sort Struktur</p> <p>Ved opskæring; opgiv om den skal skæres høj eller lav.</p> | 12 meter |
| <p>Svæveliste høj tynd</p> <p>SVH 4039 Hvid mat</p> <p>SVH 4040 Sort mat</p> <p>SVH 4065 Sort m. guld på toppen</p> <p>SVH 4066 Sort m. sølv på toppen</p> <p>SVH 4067 Hvid/guld på to sider</p> <p>SVH 4068 Hvid/sølv på to sider</p> | 12 meter |

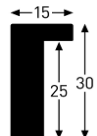
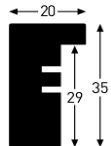
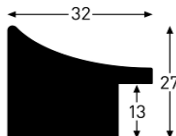
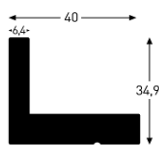
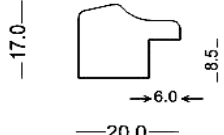
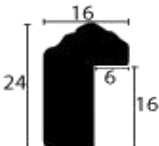
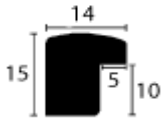
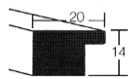
TRÆPROFILER

| | Mængden indeholder ca. |
|---|--------------------------------|
| <p>Titania</p> <p>30014 Sølv</p>  <p>30024 Sølv</p>  <p>30034 Sølv</p>  <p>30044 Sølv</p>  | <p>12 meter</p> <p>6 meter</p> |
| <p>TT</p> <p>1821-03 Sølv</p>  | <p>12 meter</p> |
| <p>Vazgen</p> <p>2317-01 Guld 2317-02 Sølv</p>  <p>2314-11 Guld 2314-12 Sølv</p>  | <p>6 meter</p> |
| <p>Veneer (fugleøje) Mat</p> <p>40116 Ulme mat 20 mm</p>  | <p>10 meter</p> |

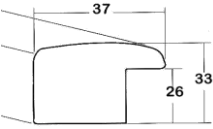
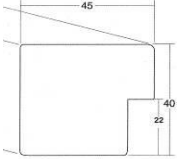
TRÆPROFILER

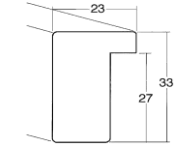
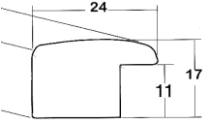
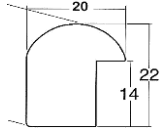
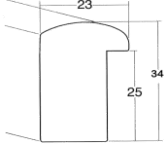
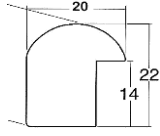
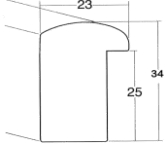
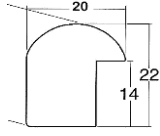
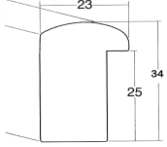
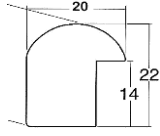
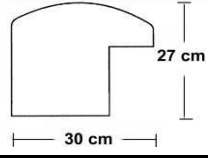
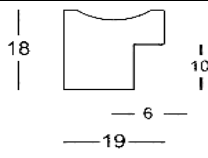
| | Mængden indeholder ca. |
|--|---------------------------|
| <p>VMF 84547 platin 84552 antrasit 84548 sort</p>   | 6 meter |
| <p>50361 sort</p>   | 6 meter |
| <p>72510 platin 72515 antrasit 72503 sort 72531 hvid</p>   | 6 meter |
| <p>22403 sort 22410 platin 22415 antrasit</p>   | 12 meter |
| <p>12010 platin 12015 antrasit 12003 sort</p>   | 12 meter |
| <p>82510 platin 82515 antrasit 82503 sort</p>   | 6 meter |
| <p>2730-01 Guld 2730-03 Sølv 2730-27 Hvid 2730-21 Sort</p>  | 6 meter |
| <p>2504 2504-01 Guld 2504-03 Sølv</p>  | 12 meter |